

ANDERSON
INTERNATIONAL CORP

**Industry-Leading Expertise.
Century-Plus Dependability.**



**Superior Oil
Pressing Solutions
That Set the
Global Standard**

Revolutionizing Oilseed Processing

In 1900, the founder of Anderson International Corp. invented the world's first continuous mechanical screw press. Compared to traditional batch processing, his Expeller® press introduced new efficiencies and cost savings for oil extraction.

All mechanical screw presses in the industry today are based on Anderson's Expeller®, which has been modified to process more than 80 types of oilseeds. By setting the global screw press standard, Anderson has become the world leader in oil extraction as we continue building on our legacy to provide the most efficient, economical equipment.

With 135+ years of manufacturing expertise, *Anderson has designed, engineered, and commissioned 12,000+ pieces of processing equipment for 1,000+ plant installations in 100+ countries.* In fact, Expeller installations from the 1920s are still in operation today—a testament to Anderson's unmatched service and durability.

What is an Expeller?

The goal of oilseed processing is to extract maximum oil from the seed using minimal energy. The Expeller® press is designed to efficiently separate liquid oil from solid seed material using continuous mechanical force, avoiding the chemicals used to dissolve oil in solvent extraction.

Powered by an electric motor, a rotating shaft pushes seeds through a screw press inside a perforated barrel. Increasing compression squeezes out the oil, which escapes through drainage openings while the solids are discharged separately—producing high-quality oil and meal with minimum energy use per ton.

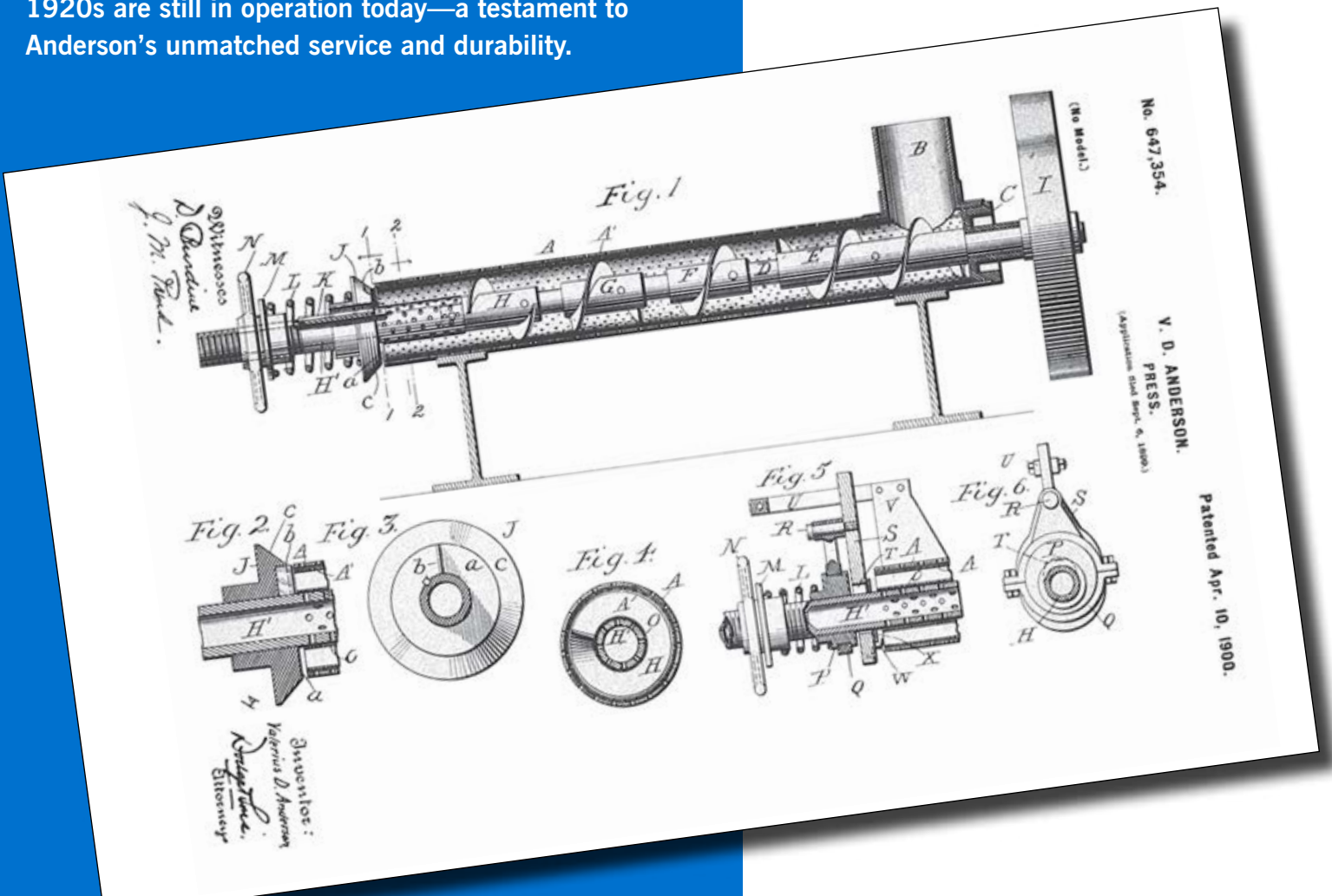

Oilseed Processing, Step By Step



Processing involves more than just feeding seed into the press. Although specific steps may vary depending on seed type and product specifications, a complete processing system typically includes:

1. **Inspection and Storage.** Silos and storage bins protect raw materials from pests, moisture, and other environmental conditions, supplying access for continual output to feed the press.
2. **Seed Cleaning.** Combinations of screeners, aspirators, magnets, and de-stoners remove foreign material from the raw oilseed, ensuring quality input and preventing damage to downstream equipment.
3. **Size Reduction.** Roller mills, hammer mills and other grinding equipment break the oilseeds into smaller pieces, increasing the exposed surface area for more efficient oil recovery.
4. **Heat Treatment.** High-shear extruders, steam-heated vessels, or gas-fired dryers apply heat to rupture the oil-bearing seed cells and deactivate harmful enzymes, hardening protein structure, reducing moisture and oil viscosity for optimal extraction.
5. **Oil Recovery.** Expellers and solvent extractors separate oil from the seed using either mechanical force or chemical solvents. Anderson Expeller® presses provide the most efficient separation without chemicals—achieving residual oil levels as low as 5%.
6. **Oil Clarification.** Screening tanks, decanters, centrifuges, and pressure leaf filters remove solid impurities from the oil and recycle these foots back into the press to maximize oil recovery.
7. **Cake Cooling and Grinding.** After the de-oiled solids or press cake are cooled, hammer mills grind the material into a meal, achieving uniform particle size to preserve quality and enable safe storage.
8. **Material Handling.** Conveyors and bucket elevators transport material throughout the processing plant until final oil and meal products are stored and transported to buyers.

Optimizing these seed preparation steps upstream of the press assures optimal performance of the Expeller—maximizing oil yields and cost efficiencies.

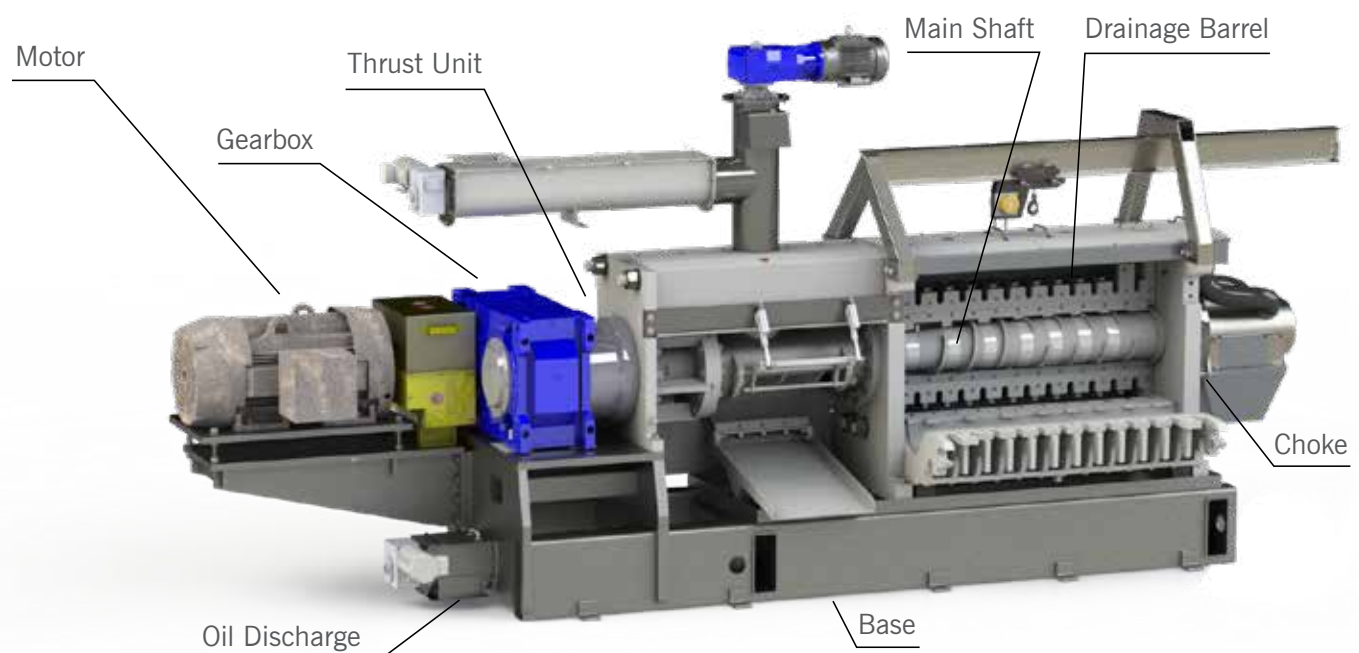

Understanding Pressing Operations

The primary function of a screw press is to separate liquid oil from solid seed material. Depending on the upstream and downstream steps before and after extraction, a press can serve various roles for different operations.

Full Pressing

A full press system crushes oilseeds to squeeze out as much oil as possible in a single pressing step. By minimizing the shaft rotation speed and maximizing the shaft compression, the press exerts maximum force, compressing seeds to extract as much oil as possible, leaving 6-8% residual oil in the meal on average. For maximum oil recovery, oilseeds should be flaked and conditioned with heat treatment upstream to achieve the optimal size, structure, moisture, and temperature before entering the press.

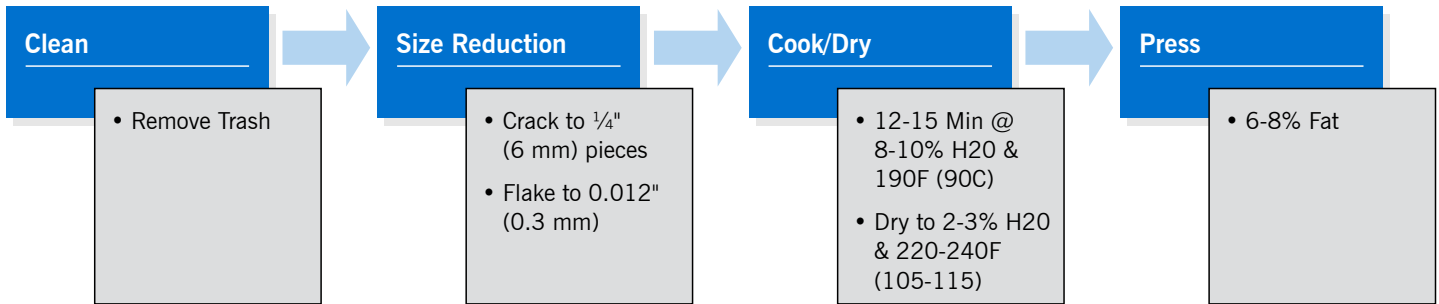

Common full-press applications include:

- Copra
- Peanuts
- Corn Germ
- Palm Kern

Pre-Pressing

Standard solvent extraction equipment is designed to process soybeans, the world's most abundant oilseed, which contain 16-22% oil by weight. Seeds with higher fat concentrations require pre-pressing in a mechanical Expeller to reduce the oil content to a similar range for efficient solvent extraction.

Compared to a full-press setup, a pre-press shaft turns faster and uses a lower compression shaft to compress seeds less aggressively, leaving about 16-20% residual oil to be extracted in the solvent extractor downstream. Technically, any press can be converted to a pre-press by increasing the shaft rotation speed (which reduces the pressing force or torque) and reducing the shaft compression.

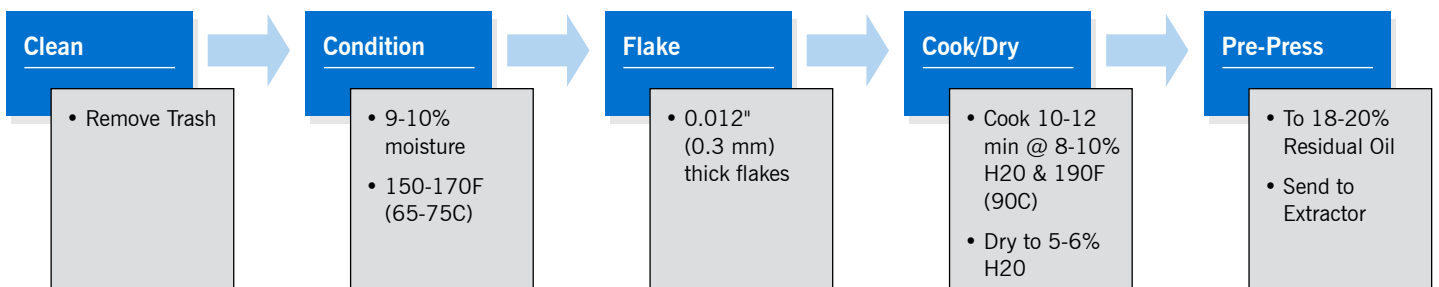

Common pre-press applications include oil-rich seeds like:

- Canola (40-45% oil)
- Sunflower seed (45-64%)
- Peanut (46-56%)
- Copra (60-65%)

Extrusion + Full Pressing

Traditional oilseed preparation uses multiple machines to crack, flake, cook, and dry material before pressing. For high-protein, low-fiber seeds that require longer cook times, a more efficient alternative is a high-shear dry extrusion system like the Anderson Dox™ Extruder, a multi-functional machine that uses mechanical energy to simultaneously shear, cook, and dry seeds without external heat or steam.

By quickly cooking seeds in about 20 seconds (compared to 20 minutes in traditional cookers), extrusion:

- Deactivates harmful enzymes
- Flash-dries excess moisture
- Preserves protein quality
- Doubles the capacity of the press
- Cuts press per-ton energy usage in half
- Doubles the life of the pressing parts
- Reduces residual oil levels to under 8%

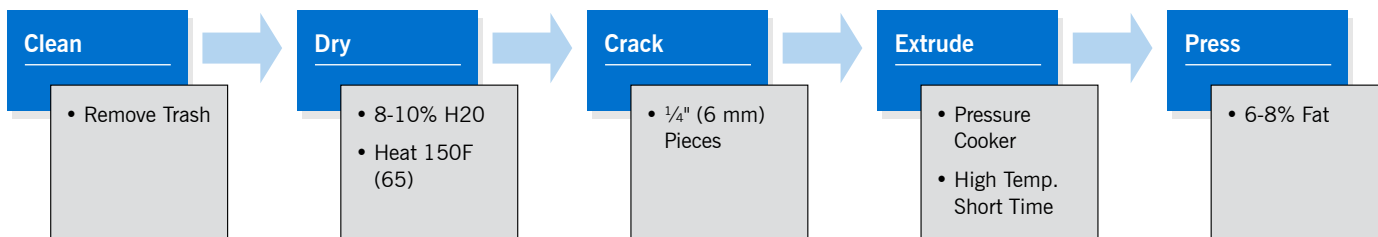

Common applications for extrusion include:

- Soybean
- Cottonseed
- Sunflower
- Canola

Double Pressing

When a single pass through a screw press struggles to recover enough oil, operators may double press—or even triple press—by running the material through two or more presses in series. This redundant workaround is inherently inefficient because it increases energy costs, processing times, space requirements, and equipment maintenance. A well-built, well-run press like the Expeller® can efficiently extract oil without extra runs.

There are scenarios at high capacities (over 500 tons per day) where a double-pressing system may reduce overall investment costs by reducing the total number of presses, but double pressing increases energy costs and typically results in higher residual oil levels in the meal with a more complex system overall. For oil mills aiming to balance operational costs and efficiencies, double pressing is NOT recommended!

Cold Pressing

Cold pressing minimizes heat exposure during processing, keeping the product cool to preserve flavors and nutrients. Unlike traditional hot pressing, seeds are not heat-treated or conditioned before extraction, while cooling systems help control temperatures during processing.

Since heat treatment breaks down seeds to release oil, removing this critical step makes extraction more challenging. While mechanical heat processing can recover up to 95% of oil, most cold presses only recover 80-85% at best.

To overcome this challenge, many cold-press oil mills run multiple presses in series or multiple passes through the press, which is highly inefficient. A more efficient alternative is the **Anderson Super Duo™ Expeller® Press**, with a unique dual-press design that maximizes yields in a single pass without the extra costs of double pressing. With the highest torque rating per ton of product, the Super Duo supercharges compression compared to a typical Expeller to offset the lack of heat treatment.

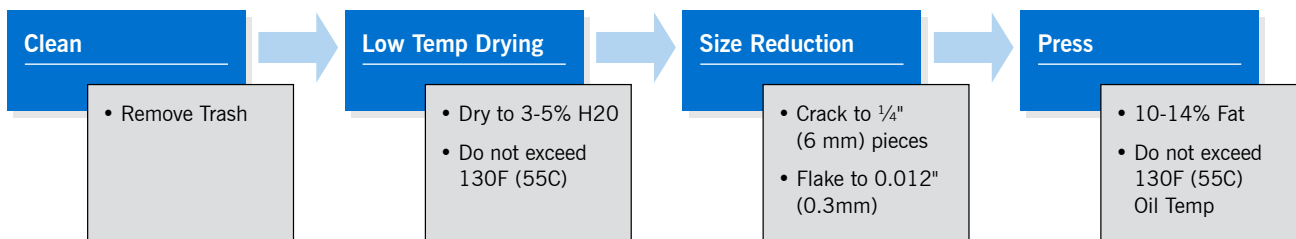

Common cold pressing applications include:

- Coconut
- Safflower seed
- Grape seed
- Flaxseed
- Sesame seed
- Hemp seed
- Sunflower seed

Super Duo™ Series Expeller®: Crushing Tough Seeds for Over a Century

Featuring two pressing sections in one powerful machine, the unique dual-press design of the **Anderson Super Duo™ Series Expeller®** provides the highest torque per ton of product to achieve the lowest possible residual oil levels in a single pass. With models from the 1920s still in operation today, Super Duo Expellers have proven to be the most durable, long-lasting presses in the industry.

Features

- Independent vertical and horizontal dual-pressing sections
- Drive and discharge end bearing support for the horizontal shaft
- Elastomeric motor coupling
- Built-in barrel cooling and flushing systems for temperature control
- Optional fixed or adjustable choke
- Optional water cooling on the horizontal shaft
- Oil cooling and closed-loop recirculation system

Applications

Used for cold pressing and full pressing of high-fiber, hard-to-process specialty oilseeds, including:

- Corn Germ
- Copra
- Palm Kernel
- Grapeseed
- Coffee Beans

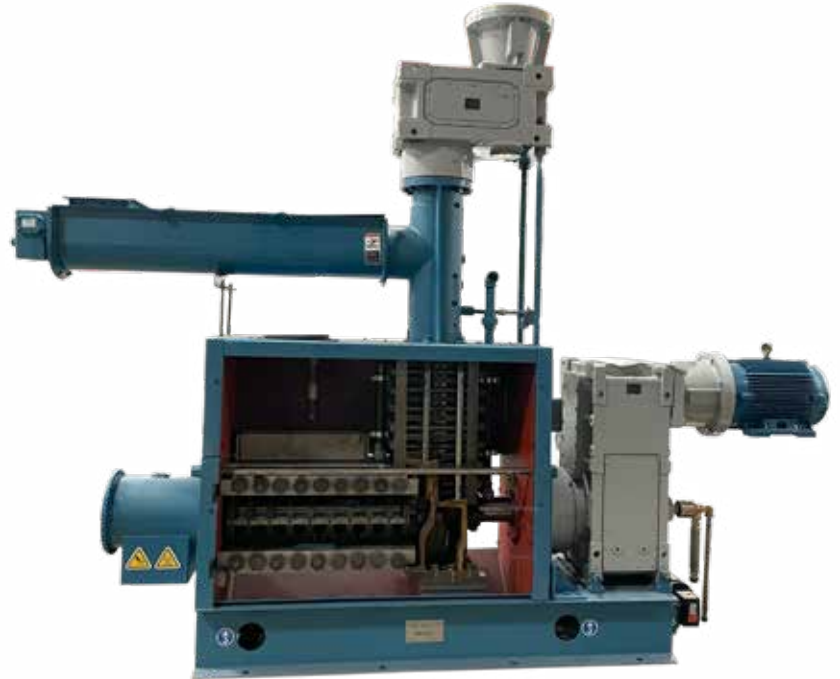

Model Specifications

Model	Overall Dimensions			Weight (Empty)	
	Length	Width	Height	lbs.	kg
Duo 600	146.03" (3709 mm)	41.63" (1057 mm)	129.25" (3283 mm)	10,175	4,615
Super Duo 600	146.03" (3709 mm)	41.63" (1057 mm)	148.88" (3782 mm)	11,035	5,005
Super Duo 1200	TBD	TBD	TBD	TBD	TBD

Performance Rating

Model	Main Drive	Force Feeder	Oil Conveyor	Application	Capacity (MTPD)
Duo 600	40-50 HP 30-37 kW	5 HP 3.73 kW	1/3 HP 0.25 kW	Full Press - Hot Full Press - Cold	10-14 8-10
Super Duo 600	50-75 HP 47-56 kW	40-50 HP 30-37 kW	1/3 HP 0.25 kW	Full Press - Hot Full-Press - Cold	20-25 16-18
Super Duo 1200	150-200 HP 112-150 kW	75-100 HP 56-75 kW	2 HP 1.5 kW	Full Press - Hot Full-Press - Cold	70-80 50-60

Lion™ Expeller® Press: Boosting Oil Recovery with Best-in-Class Design

Designed to continue Anderson's long-standing tradition of unmatched durability and efficiency, the Lion™ Expeller® Oil Press can full press over 300 metric tons per day (MTPD) of extruded material, achieving residual oil levels as low as 5% when paired with Anderson's extrusion technology. As a pre-press, the largest model can process over 800 MTPD. The Lion Expeller can pivot between oilseed applications with minimal modifications, enabling rapid adaptation to market shifts. Plus, Anderson's high-quality engineering reduces maintenance downtime, boosting profitability and ROI.

Features

- Heavy-duty helical gearbox with built-in thrust unit
- Elastomeric motor coupling
- Reversible shaft capabilities to unclog jams
- Optional removable maintenance "I" beam
- Optional fixed or adjustable choke
- Diamonbar barrel lining technology
- Quick-release, drop-out hopper system with force feeder

Applications

Used for full pressing after extrusion or pre-pressing of oilseeds, including:

- Soybean
- Canola/Rapeseed
- Sunflower
- Cottonseed



Model Specifications

Model	Overall Dimensions			Weight (Empty)	
	Length	Width	Height	lbs.	kg
Lion 600	184.06" (4675 mm)	52.93" (1344 mm)	100.56" (2554 mm)	11,600	5,261
Lion 1200	260.81" (6625 mm)	71.66" (1820 mm)	124.93" (3173 mm)	31,501	14,290
Lion 1600	344.38" (8747 mm)	72.25" (1835 mm)	141.31" (3589 mm)	43,116	19,557

Performance Rating

Model	Main Drive	Force Feeder	Oil Conveyor	Application	Capacity (MTPD)
Lion-600	75-100 HP 56-75 kW	5 HP 3.73 kW	1/3 HP 0.25 kW	Extrusion + Full Press Pre-Press	50-60 75-100
Lion-1200	300-400 224-300 kW	7.5 HP 5.6 kW	2 HP 1.5 kW	Extrusion + Full Press Pre-Press	130-150 200-300
Lion-1600	600-800 HP 450-600 kW	10 HP 7.5 kW	2 HP 1.5 kW	Extrusion + Full Press Pre-Press	300-400 600-800

Oil Screening, Recycling & Cooling: Squeezing Out Every Ounce of Profit

Pressed oil from the Expeller inevitably contains some solid seed residues called foots. Screening out these solids and recycling them back through the press is key to squeezing out every last ounce of oil and profit since the valuable liquid gold commands a much higher market price than meal.

Oil clarification is critical to maximizing yields. Expelled oil moves from the press into oil screening tanks, where gravity forces solids to settle after 45 to 50 minutes. Rotating paddles lift settled foots from the bottom of the tank and drag them across a wedge wire screen at the top, allowing free oil to drain before the solids are discharged and conveyed back into the press.

Recycled foots can contain over 50% oil by weight—recovering potentially lost profit.

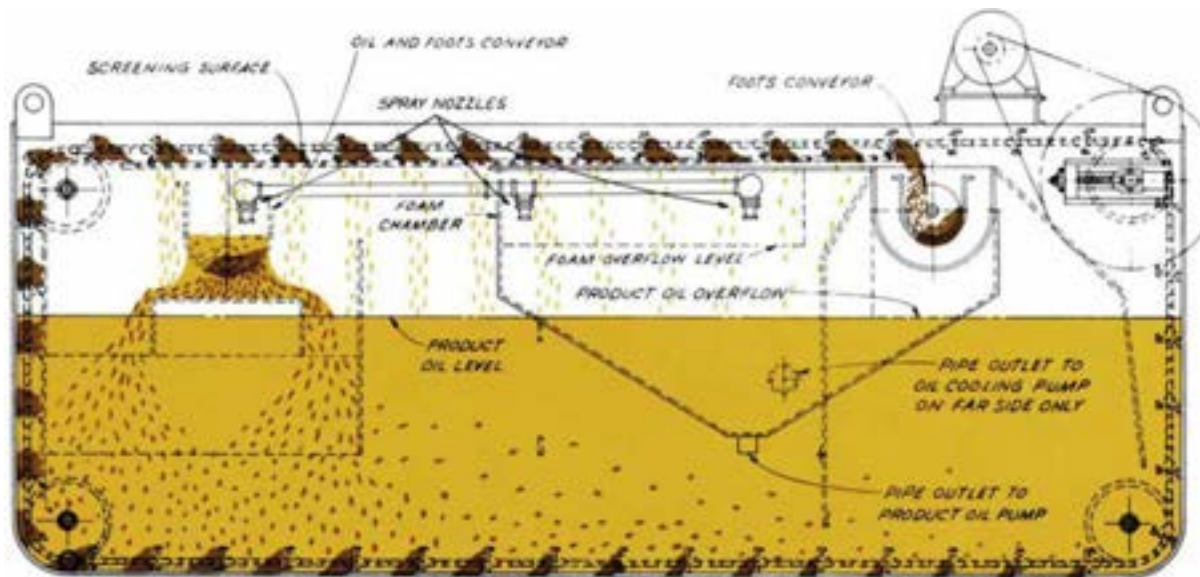

The screened oil overflows into a side chamber where it is pumped to a holding tank before the final clarification step. The screening tank will remove solids over 20 mesh or roughly 840 microns. The smaller solid particulates must be removed in a secondary clarification step, which is typically done in a filter or decanter before the oil can be sent to storage.

Though one of the simplest machines in an oilseed processing plant, the oil screening tank is the unsung hero of the mill, driven by a one-horsepower motor to recoup extra profits. A screening tank achieves ROI within a matter of months through the value of recovered oil, without adding extra energy costs or maintenance requirements.

Features

- Inspection access doors
- Minimal maintenance requirements
- Ultrasonic level sensor
- Automatic unloading

Model Specifications & Performance Rating

Model	Capacity		Overall Dimensions			Weight (Empty)	
	Gallons	Liters	Length	Width	Height	lbs.	kg
No. 6	306	1,158	144" (3658 mm)	47" (1194 mm)	95" (2413 mm)	6,300	2,858
No. 12	1,600	6,056	186" (4724 mm)	65" (1651 mm)	96" (2439 mm)	7,335	3,260
No. 18	2,500	9,463	186" (4724 mm)	90" (2286 mm)	94" (2388 mm)	8,836	4,007
No. 20	3,312	12,534	264" (6706 mm)	90" (2286 mm)	94" (2388 mm)	14,200	6,441

The Anderson Advantage: Why Our Expellers Outlast the Competition

As the original inventors of the world's first continuous screw press, Anderson International continues to dominate the mechanical extraction industry for several key reasons:

- **Superior Quality**

Proudly made in the USA, our parts are manufactured to stringent ISO 9001:2008 quality control standards and shipped anywhere in the world. Engineered from the highest quality steel and precisely machined to the tightest tolerances, our equipment sets the standard for excellence in the industry.

- **Unmatched Durability**

With Anderson Expeller installations from the 1920s still in operation today, our mechanical extraction equipment is carefully engineered to outlast the competition. In fact, our heavy-duty machines have been running longer than most of our competitors have been in business!

- **Century-Plus Longevity**

Celebrating over 135 years in business speaks volumes about our brand reputation and stability. As industry pioneers driven by continuous improvement and innovation, clients can rely on our long-lasting technology and industry-leading insight across every seed market for decades to come.

- **Deep Process Knowledge**

Our expert team brings over 700 years of combined experience in the oilseed processing industry, and more than 25% of our staff have been with Anderson for at least a decade. Our comprehensive process knowledge and specialized engineering expertise are indispensable resources for clients.

- **Lowest Cost of Ownership**

Our precisely engineered equipment extends the time between required maintenance—improving safety, reducing operating costs, and minimizing expensive downtime. Optimized for energy efficiency, our equipment runs at the lowest cost per ton to maximize oil yields and profits.

- **Client-Focused Commitment**

Clients around the world depend on Anderson to keep their plants running smoothly. We proudly stand by our products by providing end-to-end training, service, and support to help our clients achieve the best quality products, optimal yields, and maximum ROI from our equipment.

When you purchase equipment from Anderson International, you're not just buying a screw press—you're investing in an industry-leading system that's built to last and surrounded by a lifetime of support.



Anderson Aftermarket Service & Support: Keeping Customers Crushing

Even the highest-quality heavy-duty Expellers gradually wear down from crushing tons of tough seed material over time. Regular service, maintenance, repairs, and rebuilds are critical to optimize the performance of your equipment—keeping oil and profits flowing at peak capacity.

Screw press maintenance requires a depth of technical know-how and specialized tooling. When every second of downtime cuts into the bottom line, customers count on Anderson for reliable aftermarket service, support, and spare parts to quickly resume pressing. Our certified technicians have unmatched expertise in analyzing, servicing, and optimizing oilseed operations of every size and market niche.

Anderson's service team proudly stands behind our products to offer clients a full spectrum of support:

- **Startup Commissioning** to thoroughly test new installations against stringent safety standards
- **Engineering Design Support** to efficiently lay out complete plants and modify existing systems
- **Operations Training** to develop SOPs and teach your team safe and proper use of equipment
- **Maintenance Training** to guide operators through approved service protocols for each machine
- **On-Site Troubleshooting** to diagnose mechanical or process issues and provide timely fixes
- **Field Service Calls** to carefully inspect machines during routine maintenance turnarounds
- **Process Audits** to analyze processing inefficiencies and optimize system-wide workflows
- **Equipment Rebuilds & Repairs** to refurbish aging equipment back to optimal performance
- **OEM Spare Parts** manufactured to Anderson's strict quality standards and precise specifications
- **Dedicated Inventory Program** to stock spare parts in our warehouse, saving time and money



Anderson's global network of sales representatives, agents, and business partners provides local support and service around the world, supplemented by real-time virtual training and data-sharing technology.

By trusting Anderson's aftermarket service and support, clients can unlock benefits like:

- Optimizing press performance and capacity
- Maximizing oil yields and product quality
- Extending the operational life of equipment
- Preventing costly damage and downtime
- Enhancing production processes and profits
- Protecting plant workers by ensuring safety
- Minimizing unnecessary energy costs
- Boosting operational efficiencies and cost savings

Contact us to schedule your Expeller maintenance now!



Looking for a press that will
outrun the competition?

Invest in the best.

A premium supplier of oil pressing
equipment for mechanical & chemical
extraction, Anderson International continues
building on its legacy:

*"To be recognized as the world leader in
providing complete processing lines utilizing
superior process technologies for the
separation of liquid from solids."*

Our success depends on the profits our
customers reap from our technology &
support.

Ready to upgrade your processing
plant with a press designed to
crush and built to last?

Contact us to request a quote
tailored to your operation.

BY THE NUMBERS

1888

ANDERSON FOUNDED IN CLEVELAND

135+

YEARS OF PROCESSING EXPERTISE

1900

ANDERSON INVENTED THE EXPPELLER PRESS

700+

YEARS OF COMBINED STAFF EXPERIENCE

12,000+

machines sold

1,000+

plant installations

100+

countries served

80+

oilseeds crushed



ANDERSON
INTERNATIONAL CORP

4545 Boyce Parkway, Stow, Ohio 44224
Phone: (216) 641-1112
Toll-Free: 1(800) 336-4730
andersonintl.com